

Scoring

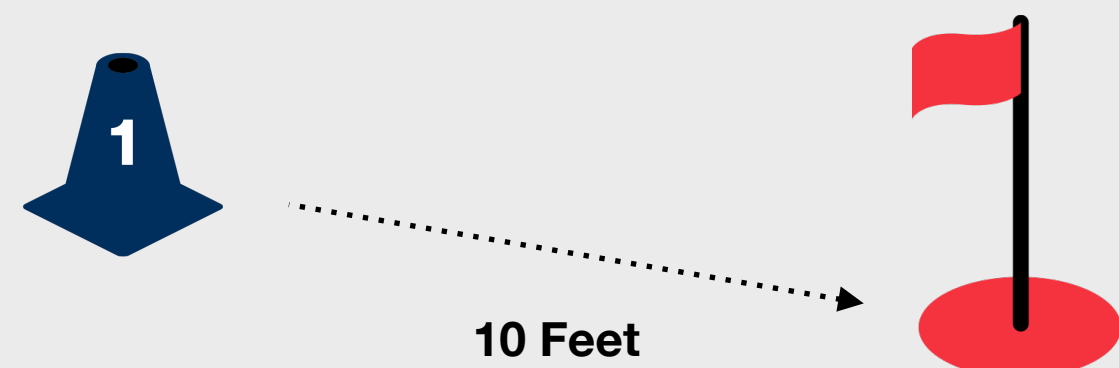

Scoring Challenge

Option 1



X 3

12 putts or less

Option 2

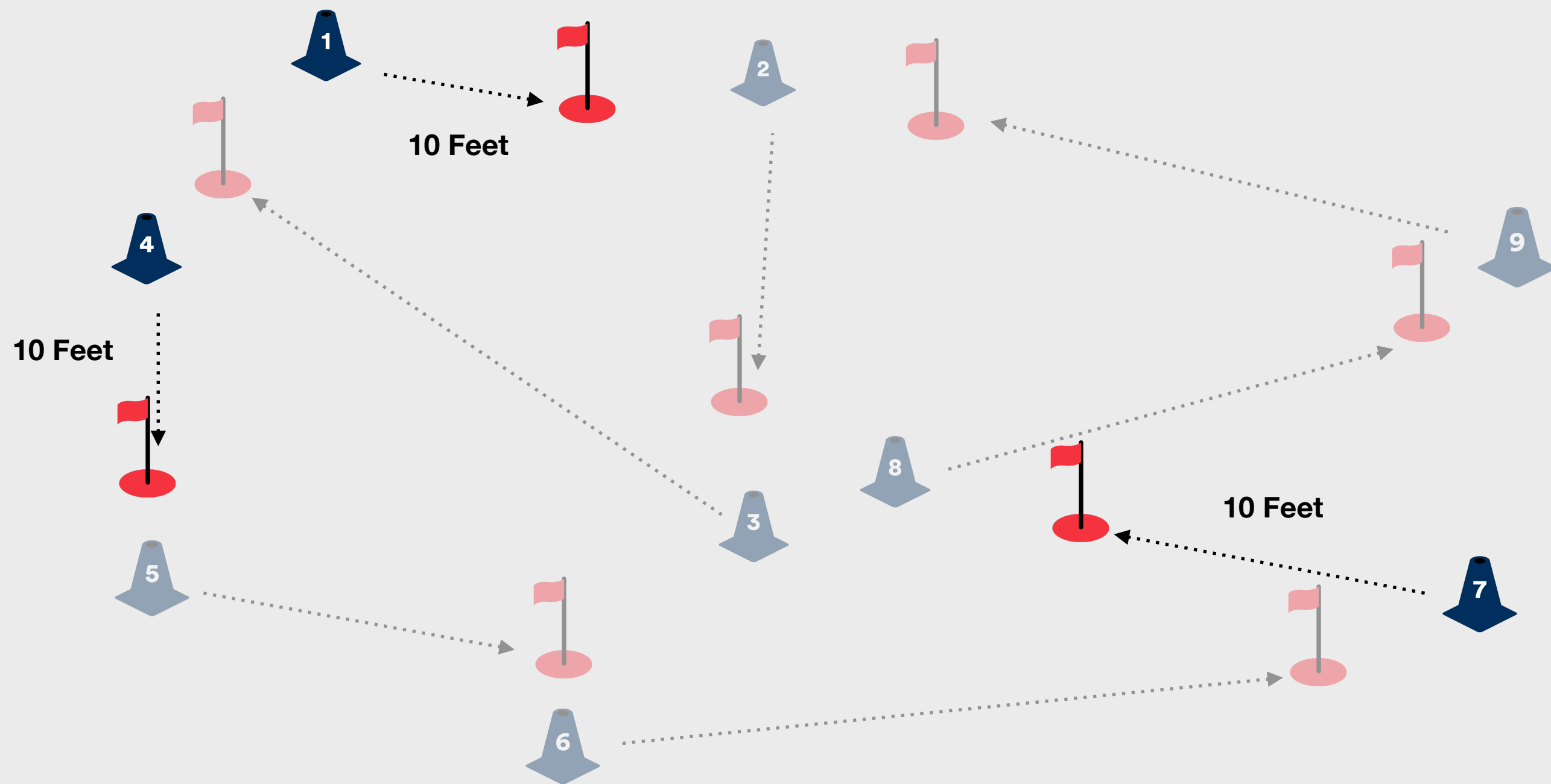

The Challenge

To complete the Level 1 Challenge within the Scoring skill element, the child needs to score 12 putts or less over 3 holes on the putting green starting 10 feet away on each hole.

What to do next?

If the child completes the challenge, they can color in the first level of the Scoring section of the On the Green myGame Wheel and add a Sticker to their Level 1 Tracker Sheet.

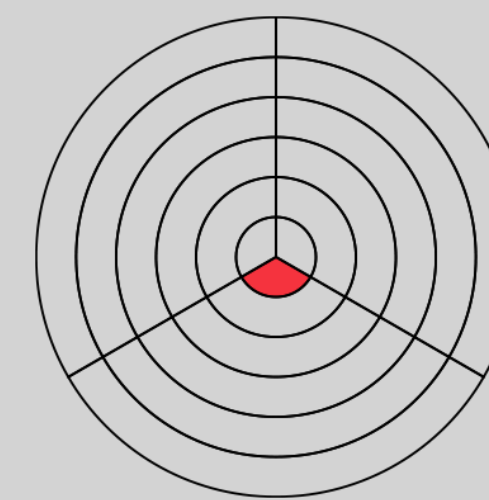

Scoring



Scoring Challenge

Option 1

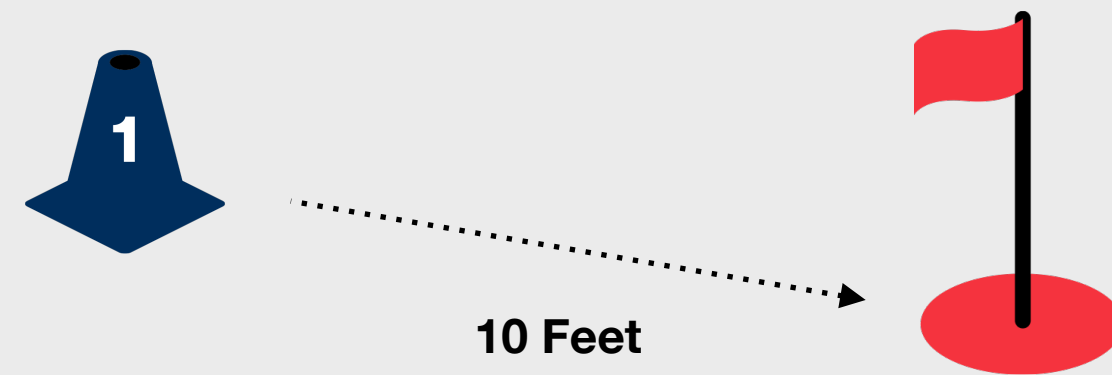

X 6

21 putts or less

Option 2

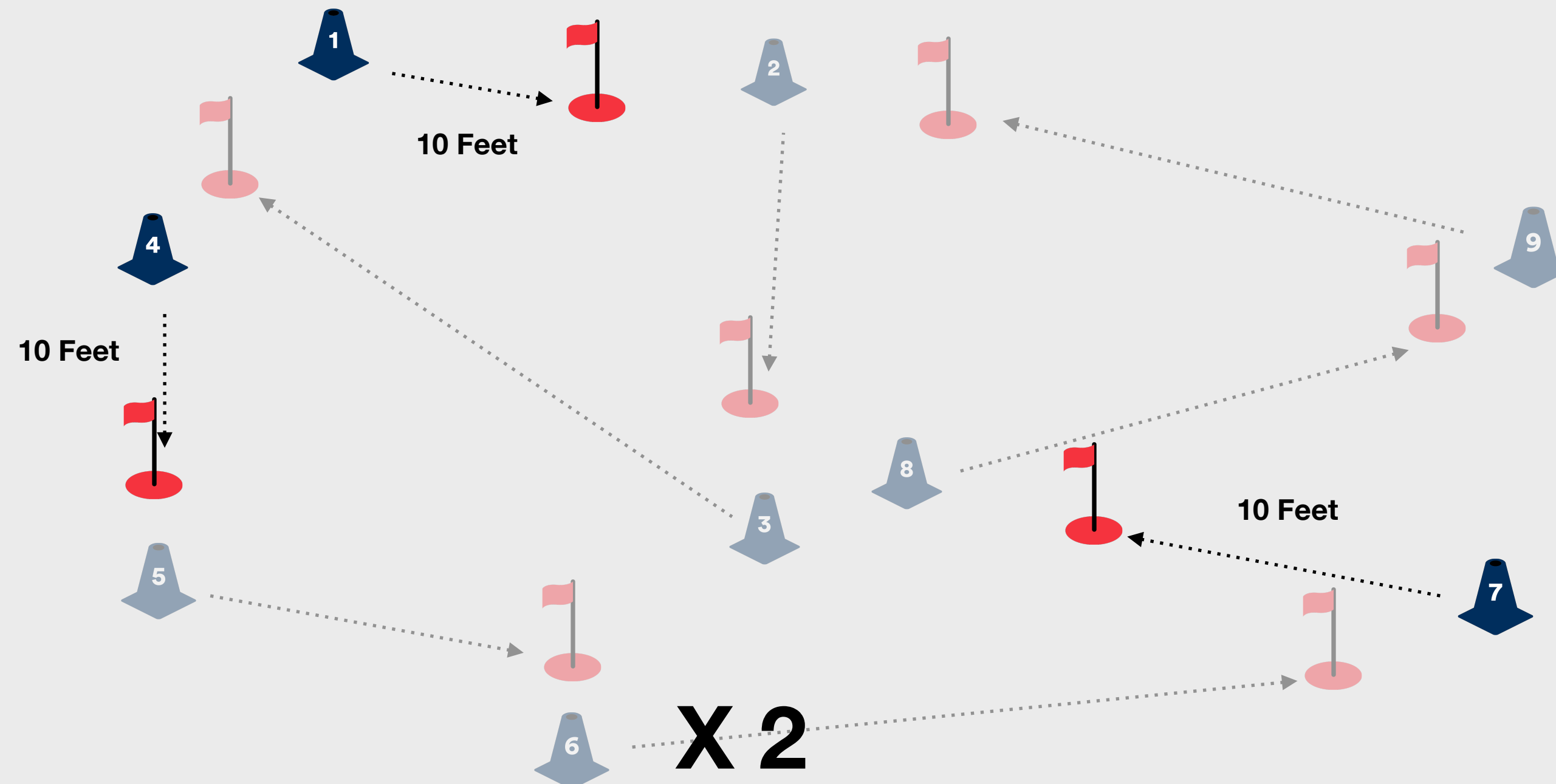

The Challenge

To complete the Level 2 Challenge within the Scoring skill element, the child needs to score 21 putts or less over 6 holes on the putting green starting 10 feet away on each hole.

What to do next?

If the child completes the challenge, they can color in the second level of the Scoring section of the On the Green *myGame Wheel* and add a Sticker to their Level 2 Tracker Sheet.

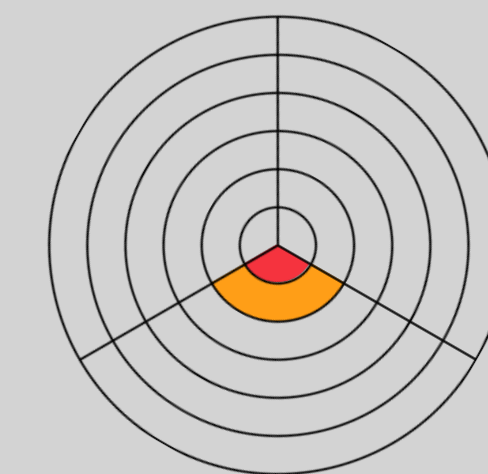

Scoring



Scoring Challenge

Option 1



18 putts or less

Option 2

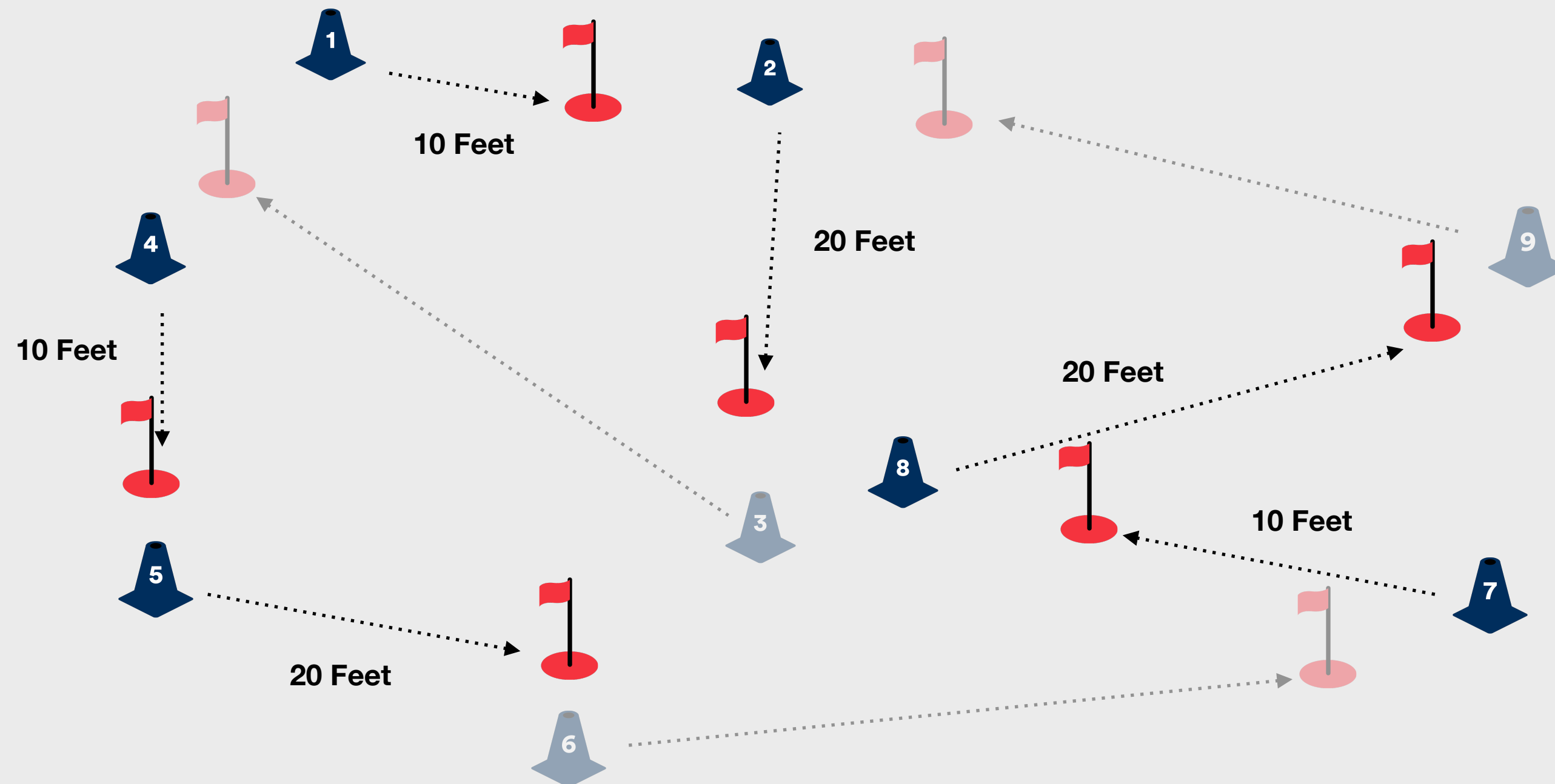

The Challenge

To complete the Level 3 Challenge within the Scoring skill element, the child needs to score 18 putts or less for 6 holes on the putting green, playing 3 holes at a starting distance of 10 feet and 3 holes at a starting distance of 20 feet from the hole.

What to do next?

If the child completes the challenge, they can color in the third level of the Scoring section of the On the Green myGame Wheel and add a Sticker to their Level 3 Tracker Sheet.

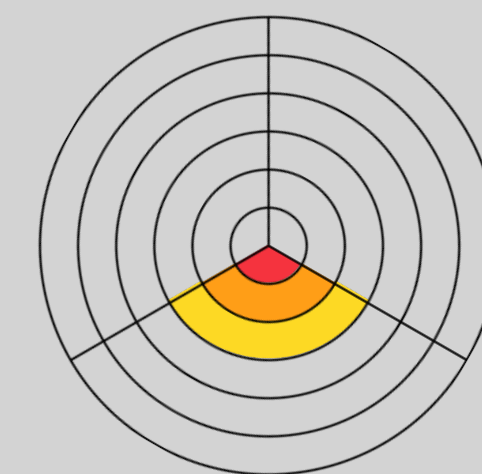

Scoring



Scoring Challenge

Option 1

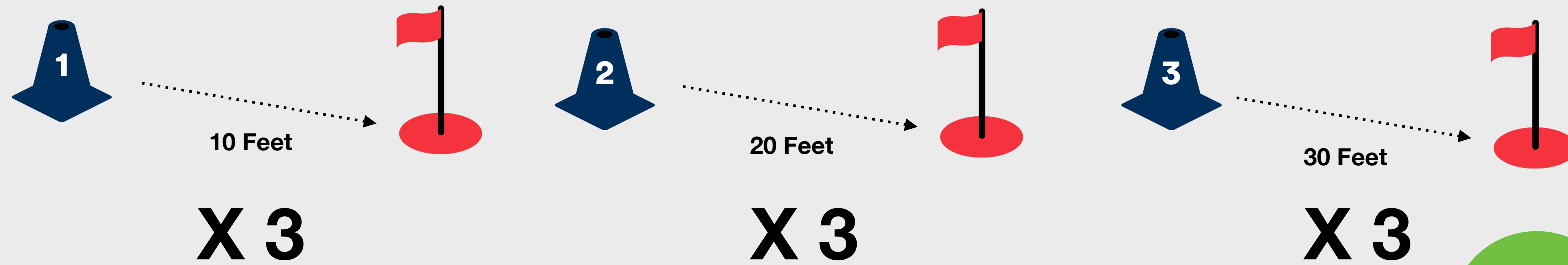

Option 2

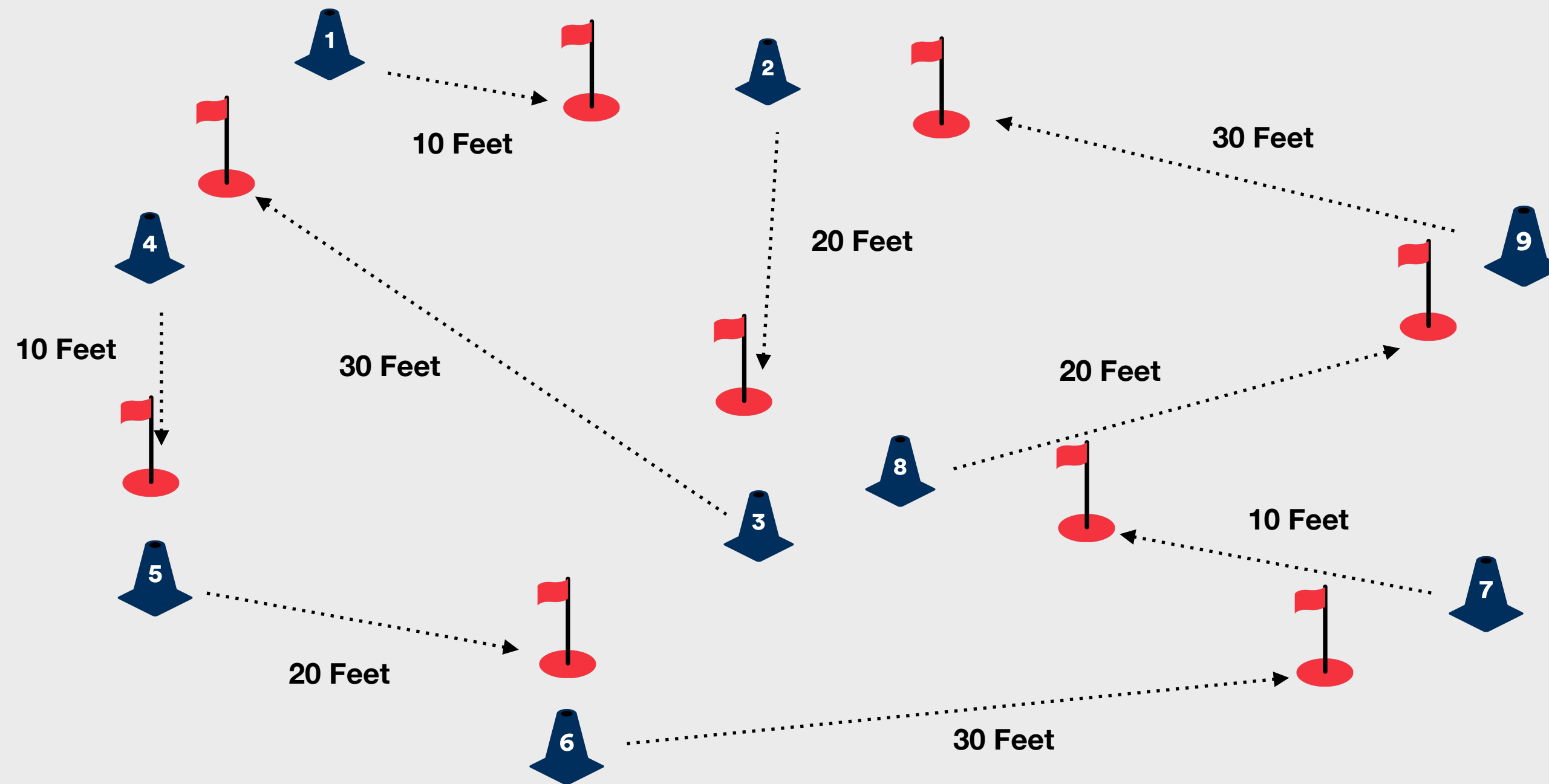

24 putts or less



The Challenge

To complete the Level 4 Challenge within the Scoring skill element, the child needs to score 24 putts or less for 9 holes on the putting green, with 3 holes at a starting distance of 10 feet, 3 holes at a starting distance of 20 feet and 3 holes at a starting distance of 30 feet from the hole.

What to do next?

If the child completes the challenge, they can color in the fourth level of the Scoring section of the On the Green myGame Wheel and add a Sticker to their Level 4 Tracker Sheet.

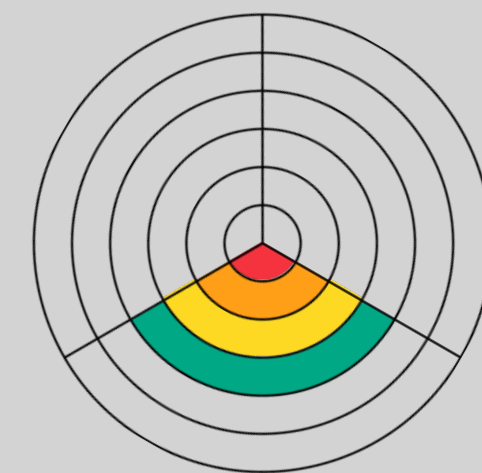

Scoring



Scoring Challenge

Option 1

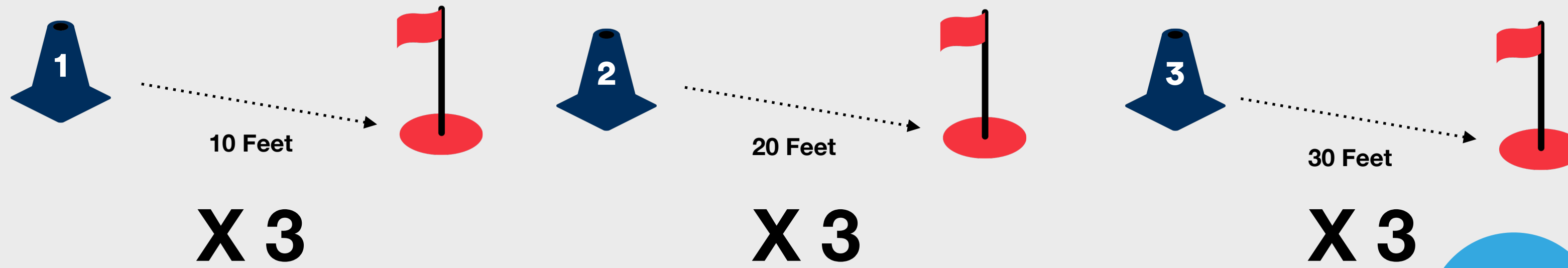

21 putts or less

Option 2

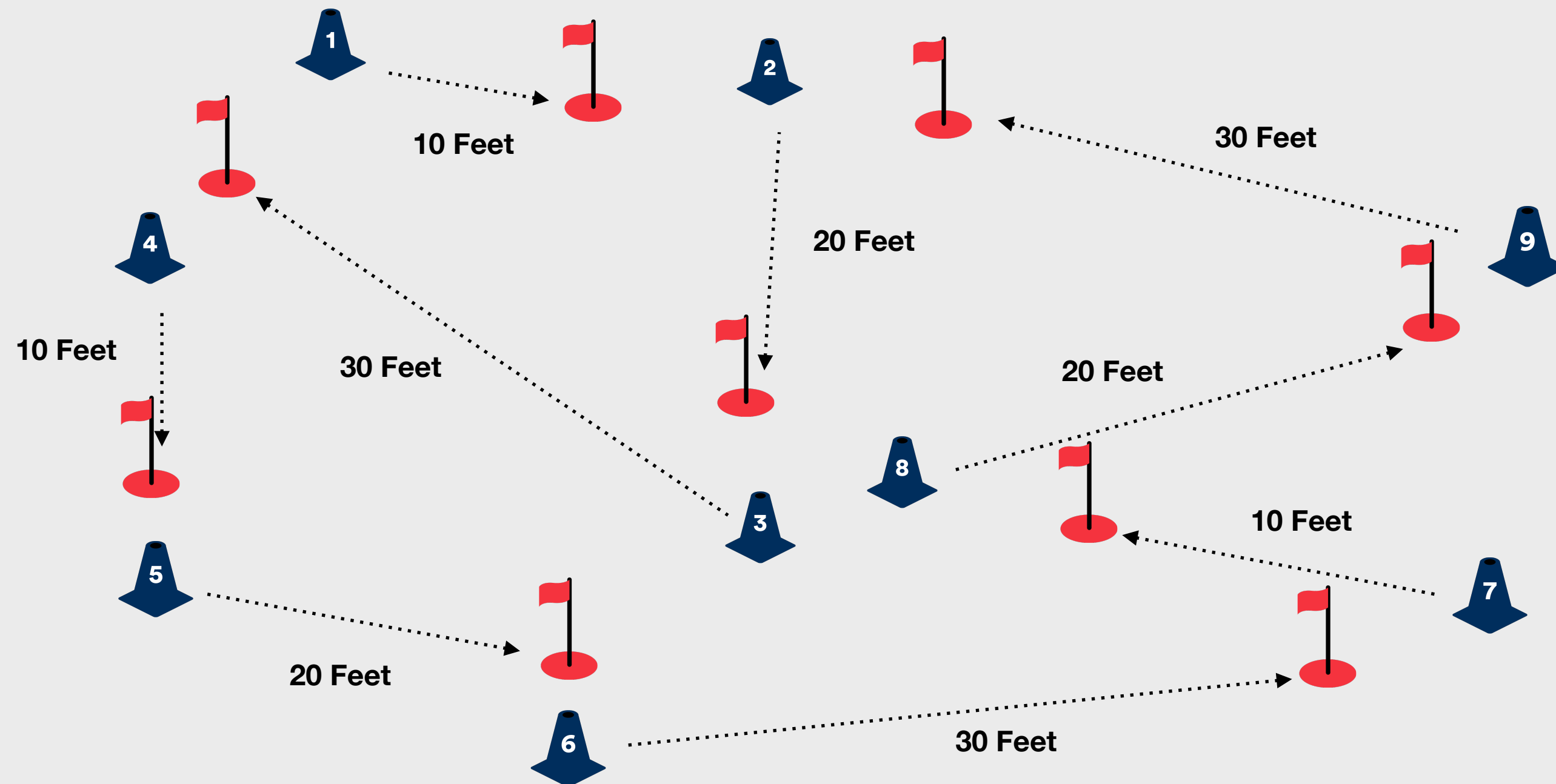

The Challenge

To complete the Blue Sticker Challenge within the Scoring skill element, the child needs to score 21 putts or less for 9 holes on the putting green, with 3 holes at a starting distance of 10 feet, 3 holes at a starting distance of 20 feet and 3 holes at a starting distance of 30 feet from the hole.

What to do next?

If the child completes the challenge, they can color in the fifth level of the Scoring section of the On the Green myGame Wheel and add a Sticker to their Level 5 Tracker Sheet.

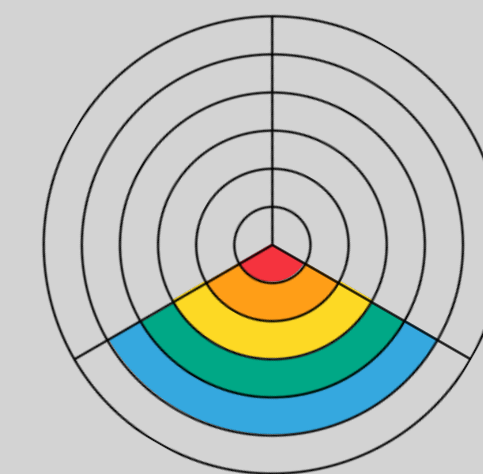

Scoring



Scoring Challenge

Option 1

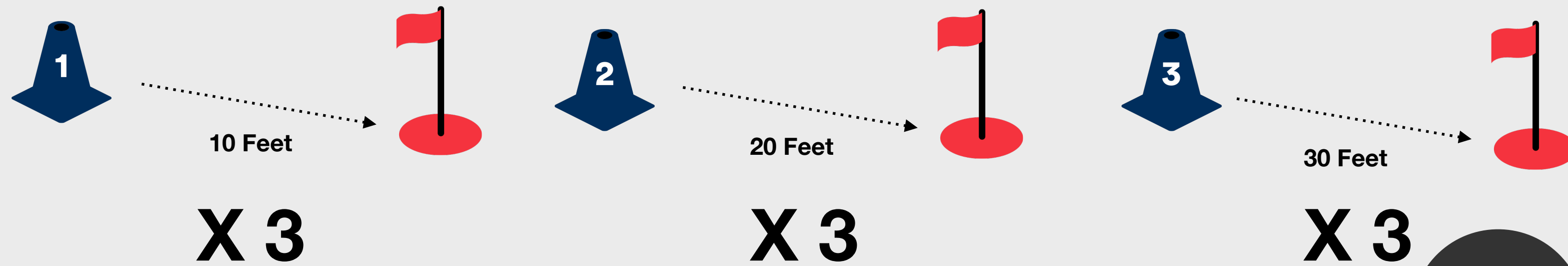

18 putts or less

Option 2

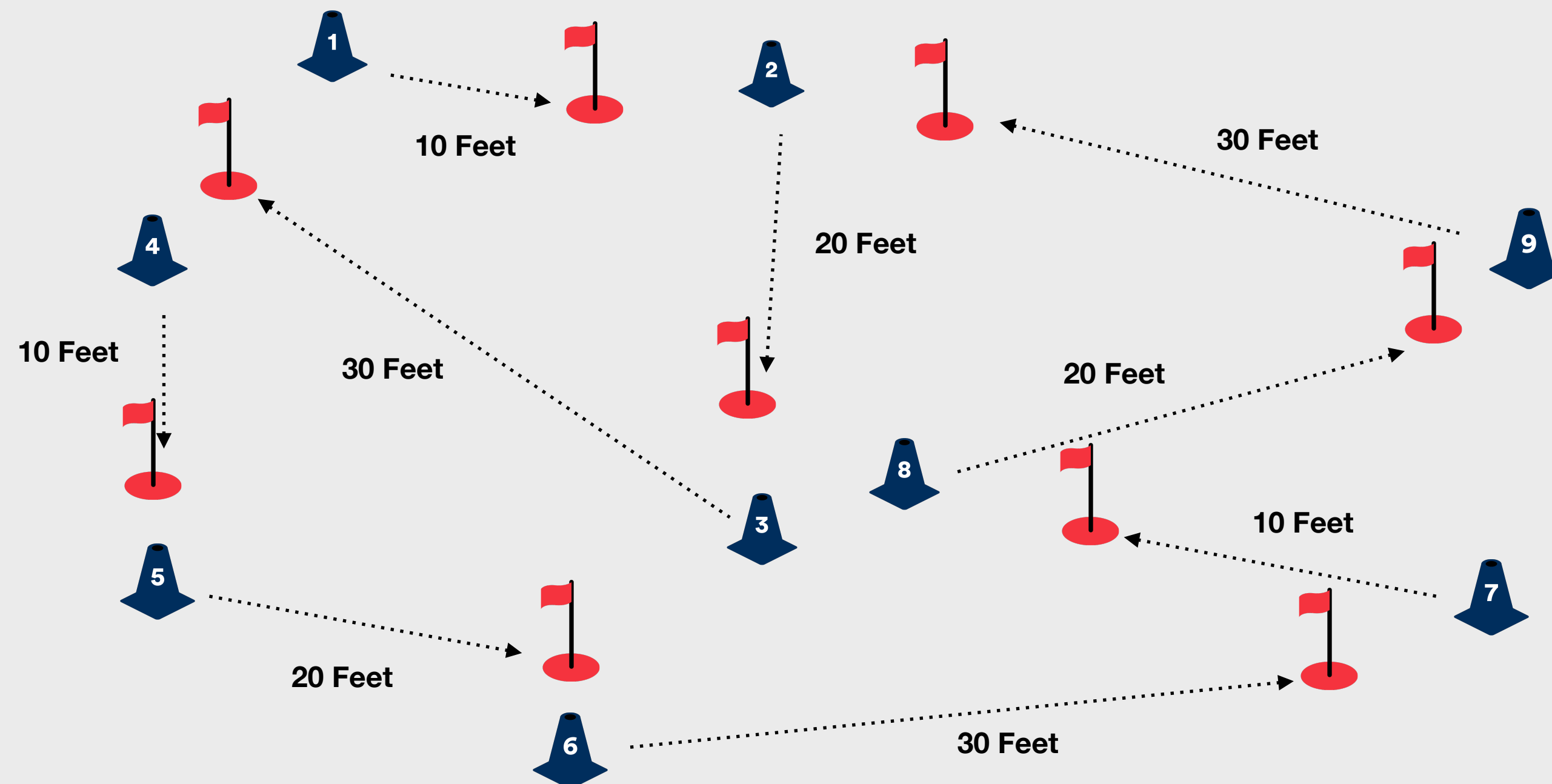

The Challenge

To complete the Level 6 Challenge within the Scoring skill element, the child needs to score 18 putts or less for 9 holes on the putting green, with 3 holes at a starting distance of 10 feet, 3 holes at a starting distance of 20 feet and 3 holes at a starting distance of 30 feet from the hole.

What to do next?

If the child completes the challenge, they can color in the sixth level of the Scoring section of the On the Green myGame Wheel and add a Sticker to their Level 6 Tracker Sheet.

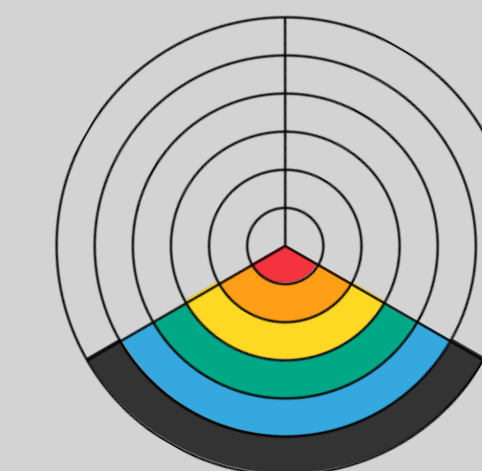

Scoring



Thank you.

